

Softwood Decking Walkway Kit

Fitting Guide

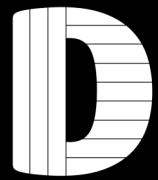

Guidance Notes

Our kits can be assembled easily using the following instructions and can be used on their own or joined together to create whichever configuration you might want.

We want you to enjoy your deck purchase for many years to come and by following a few simple steps you will be able to ensure this happens.

Please take time to read the assembly instructions carefully before erecting your decking kit and check all parts prior to assembly.

Ensure before starting construction that you have a level working area to install your frame, be this on paving slabs, gravel or well draining ground (grass/soil).

To complete your build you may also require Membrane, Fascia Boards, Corner Dolly's, Stain, and Additional Joists to strengthen which are not provided as part of a standard kit.

Please Note: In some instances your joists may require trimming to size to make your frame the correct / exact size.

Maintenance

All timber decking can become slippery when wet or in situations where standing water is present. You should exercise caution when the surface is wet.

It is important that the deck surface is kept clean by regular brushing with a stiff bristle brush to remove dirt, algae and dead leaves which could make the deck slippery in the wet.

Periodic cleaning to remove moss and lichen will reduce the risk of slipping.

We recommend staining, treating or oiling your deck when complete to maximise its lifespan.

Recommended Tools

Drill Driver

PZ2 Driver Bit

Pencil

Tape Measure

Hand Saw

Spirit Level

For all kits we recommend a minimum of two people for safe assembly.

Softwood Decking Walkway Kit

Fitting Guide

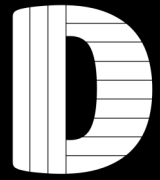

Step 1

BUILD YOUR FRAME

This is an example of a decking walkway frame.

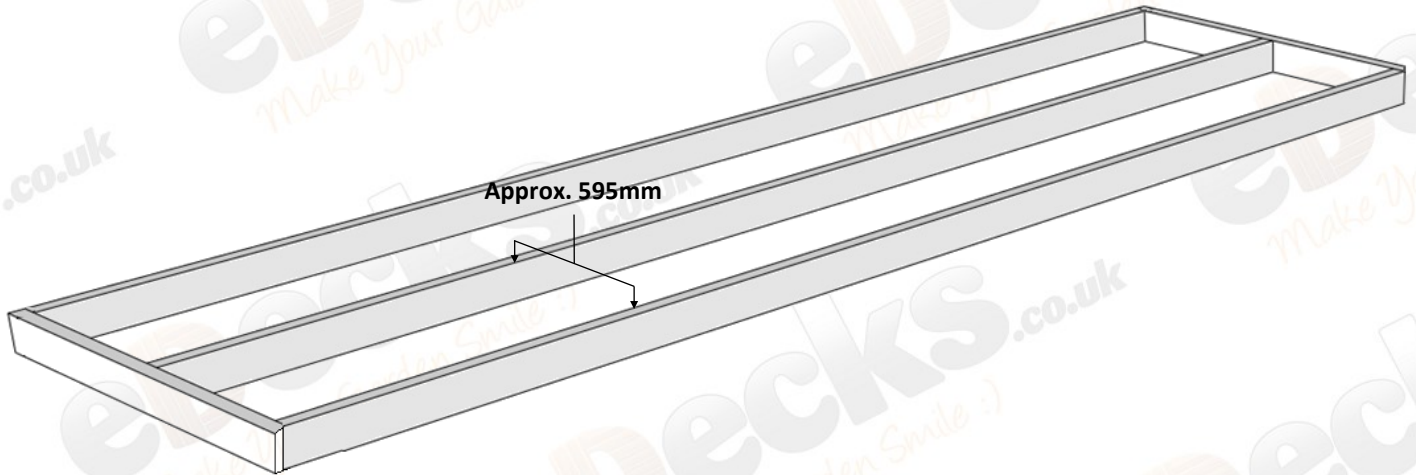

Using the decking joists provided in the Kit (3 1/2" x 1 1/2") build the perimeter first then evenly spread the remaining decking joists inside as shown in the example above, using the 4" x 10g joist screws from the fixing kit.

METHOD FOR SCREWING JOISTS

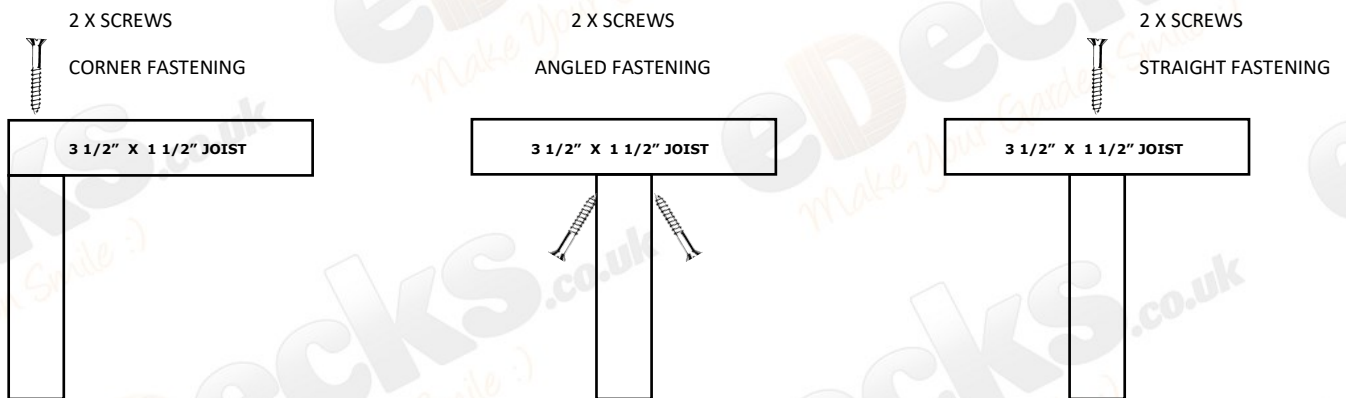

JOIST TOP VIEW

All images are for illustration only. Please see individual item listings for actual item specifications.

Softwood Decking Walkway Kit

Fitting Guide

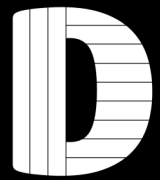

Step 2

INSTALLING THE DECKING BOARDS

Decking boards should fit exactly to the frame, working in the opposite direction to the joist work, when laying the boards make sure you leave an expansion gap between each board as per your personal preference, we recommend 10mm for the perfect fit.

Use 2 x screws per board, per joist

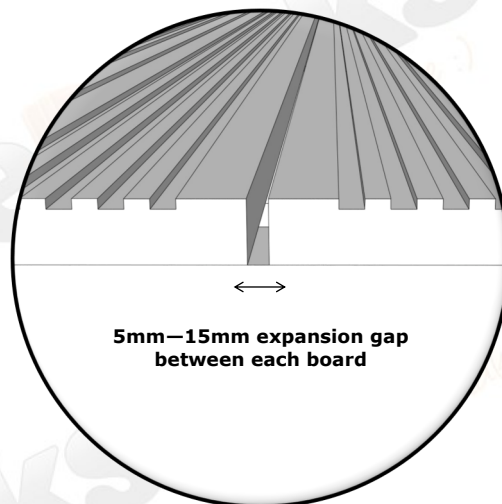
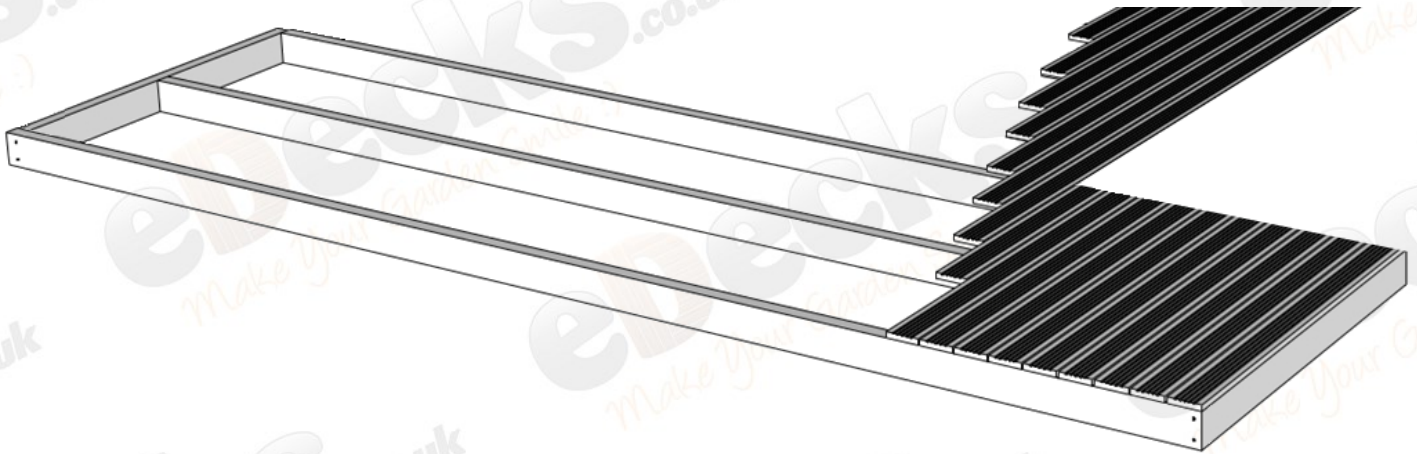

Don't forget to check your work with a level as you go!

Softwood Decking Walkway Kit

Fitting Guide

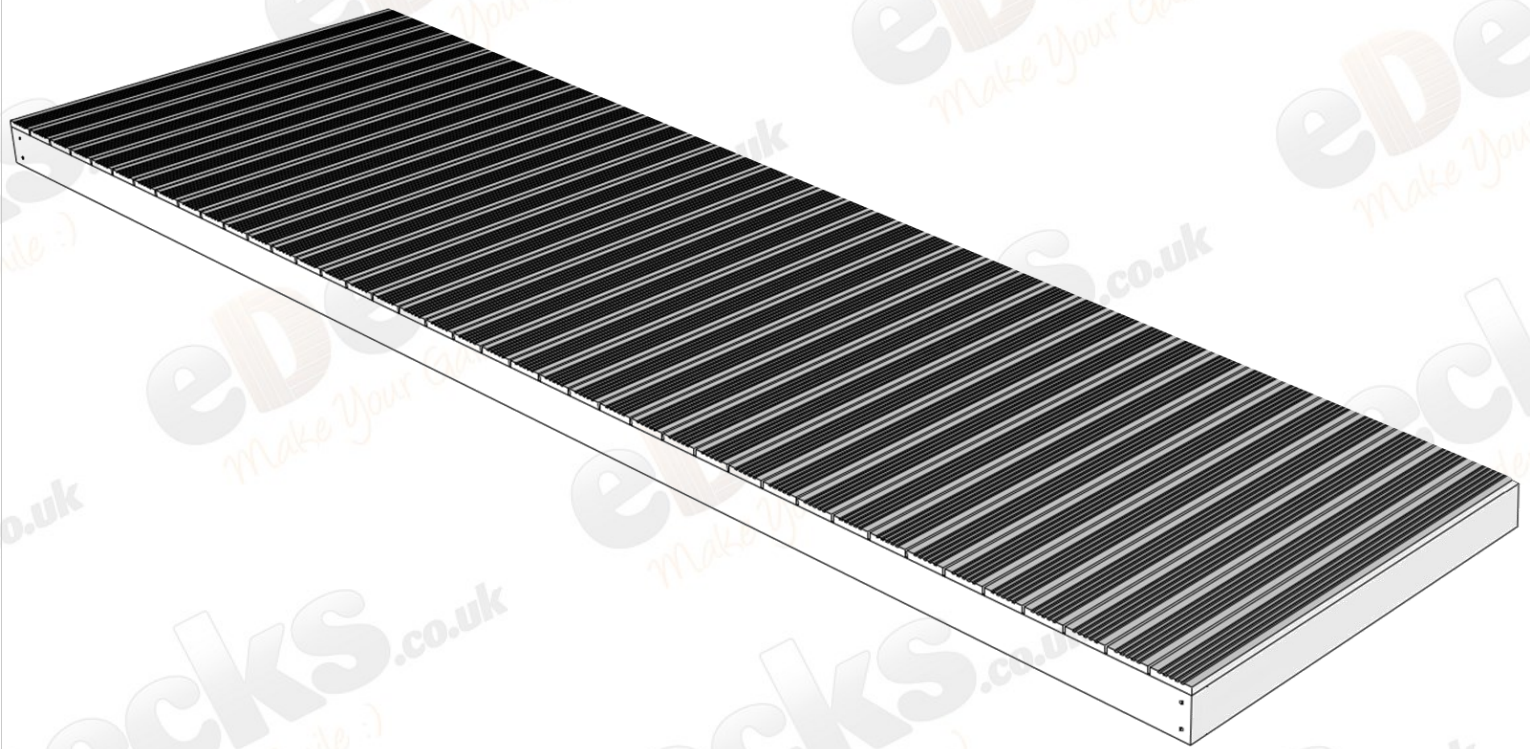
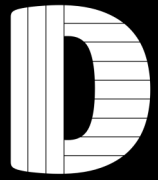

Enjoy your new Decking Walkway!

All images are for illustration only. Please see individual item listings for actual item specifications.

Page 4 of 9