



Step 1

LAY YOUR FRAME

This is an example of a decking frame

FRAME TO BE LAID ONTO PAVING SLABS, OR ONTO GRASS OR SOIL

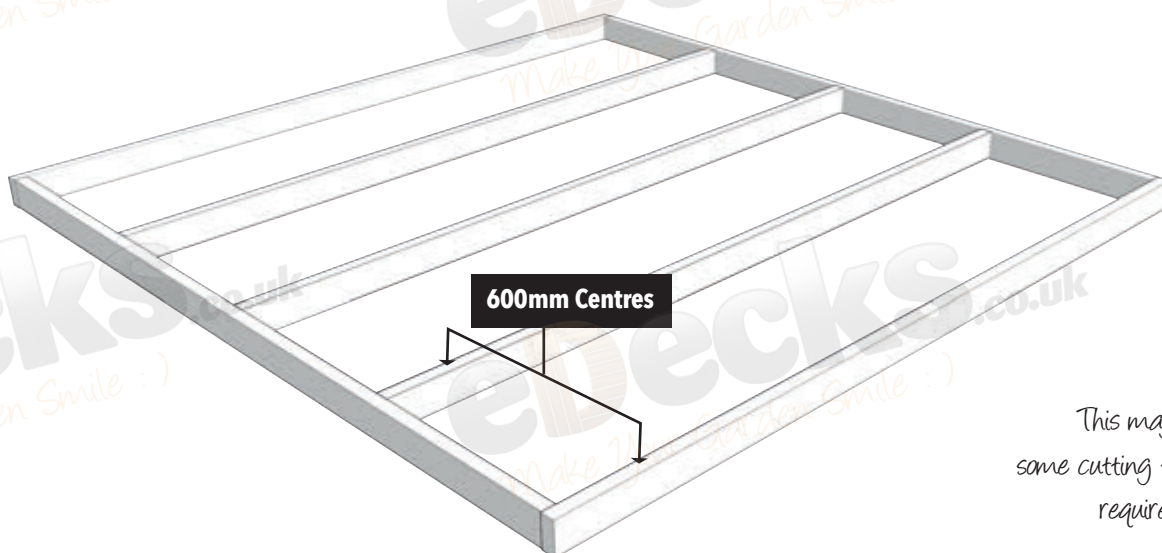

This may require some cutting to fit your size requirements

Using the decking joists provided in the Kit (3 1/2" x 1 1/2") build the perimeter first then evenly spread the remaining decking joists inside as shown in the example above, using the 4" x 10g joist screws from the fixing kit.

PLEASE NOTE you may also require Membrane, Fascias, Corner Dolly's, Stain & Additional Joists to strengthen (not provided in kit)

METHOD FOR SCREWING JOISTS

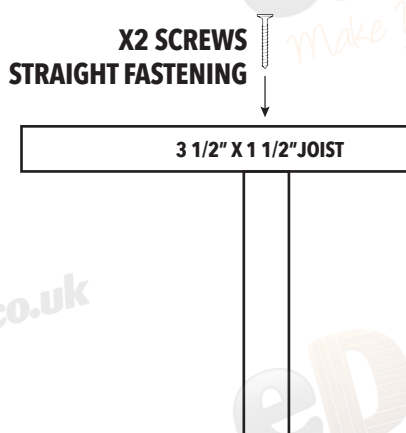
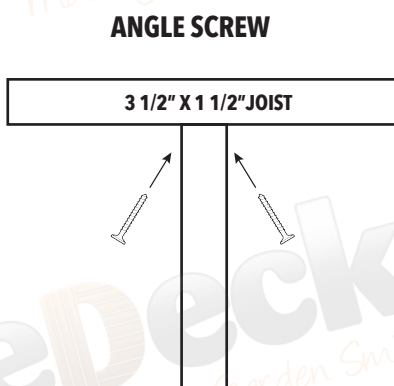
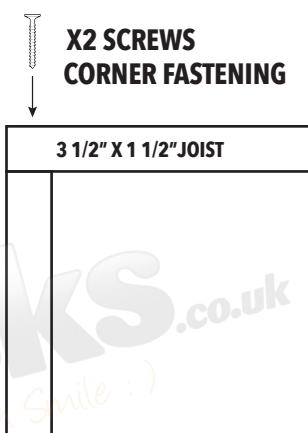

JOISTS TOP VIEW

Please make sure the frame fits the requirements for your chosen kit.

Don't forget to check your work with a level as you go!



Step 2

FITTING THE NEWELS (IF INCLUDED)

If your kit includes handrails please follow the instructions on this page, else please proceed to next step.

Each newel needs securing in each corner (**fig A**) and depending on your kit size might also need securing on the side (**fig B**) do so using the Carriage Bolts.

Install all the newels so your kit begins to look like the diagram...

JOISTS TOP VIEW

A. SECURE AT CORNER

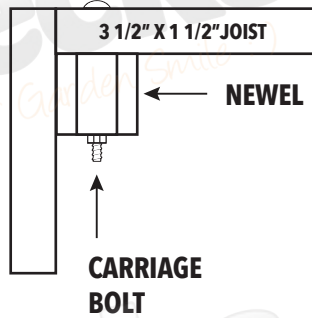

B. SECURE AT SIDE

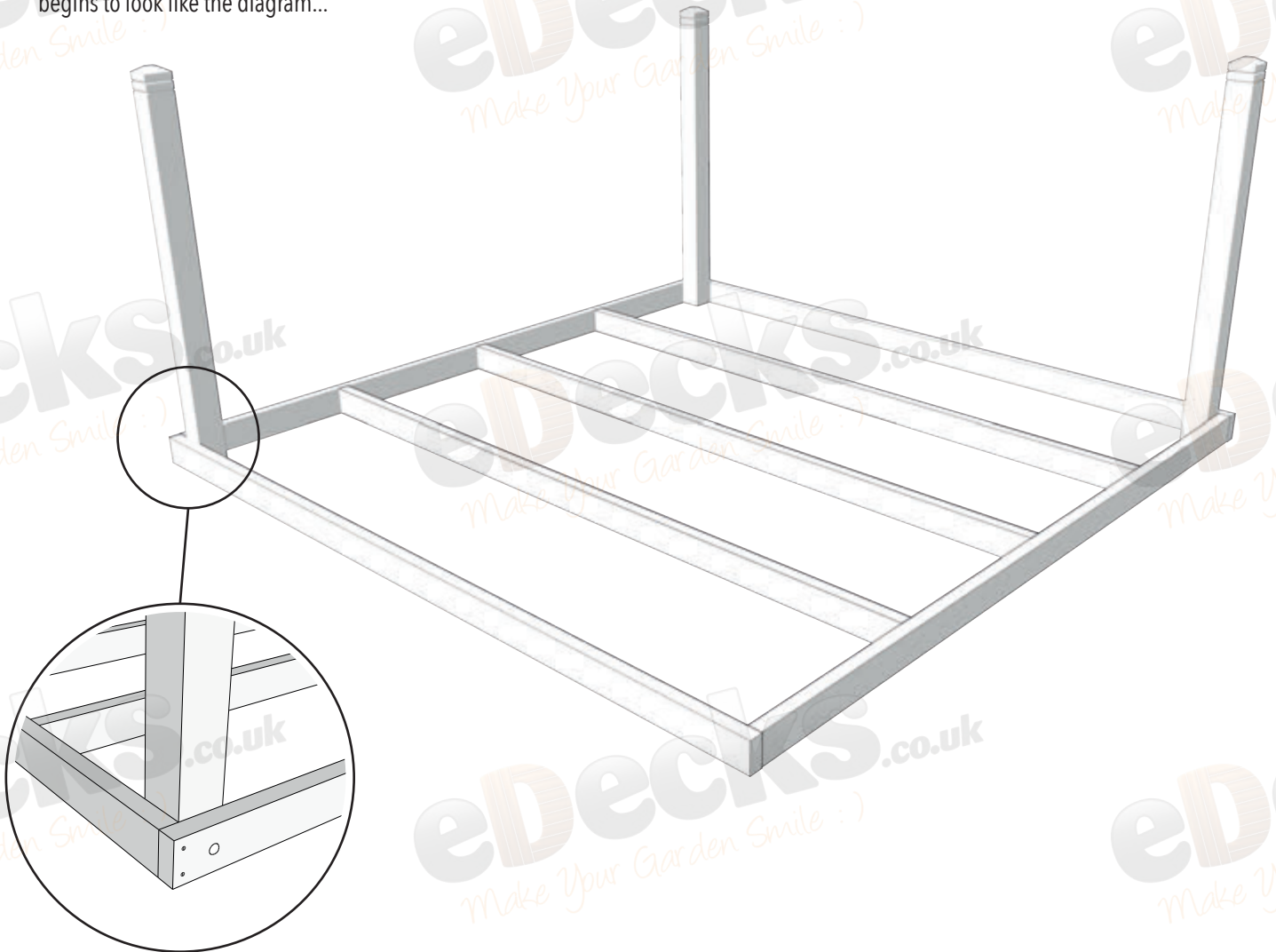
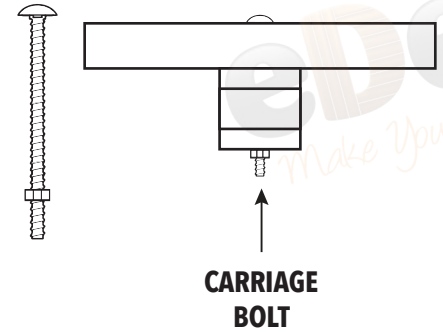

Don't forget to check your work with a level as you go!



Step 3

INSTALL DECKING BOARDS

Decking boards should fit exactly to the frame, working in the opposite direction to the joist work, when laying the boards make sure you leave a 5mm gap between each board

Cutting will be required around the Newels if applicable

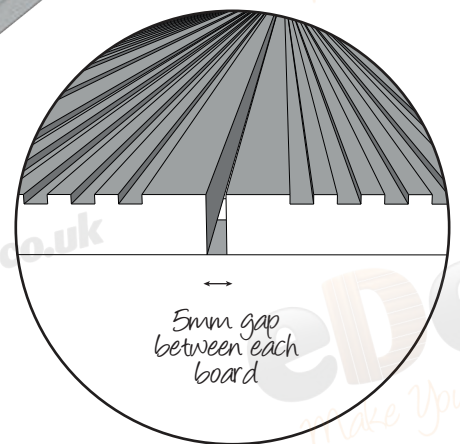
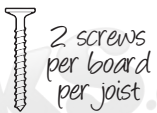
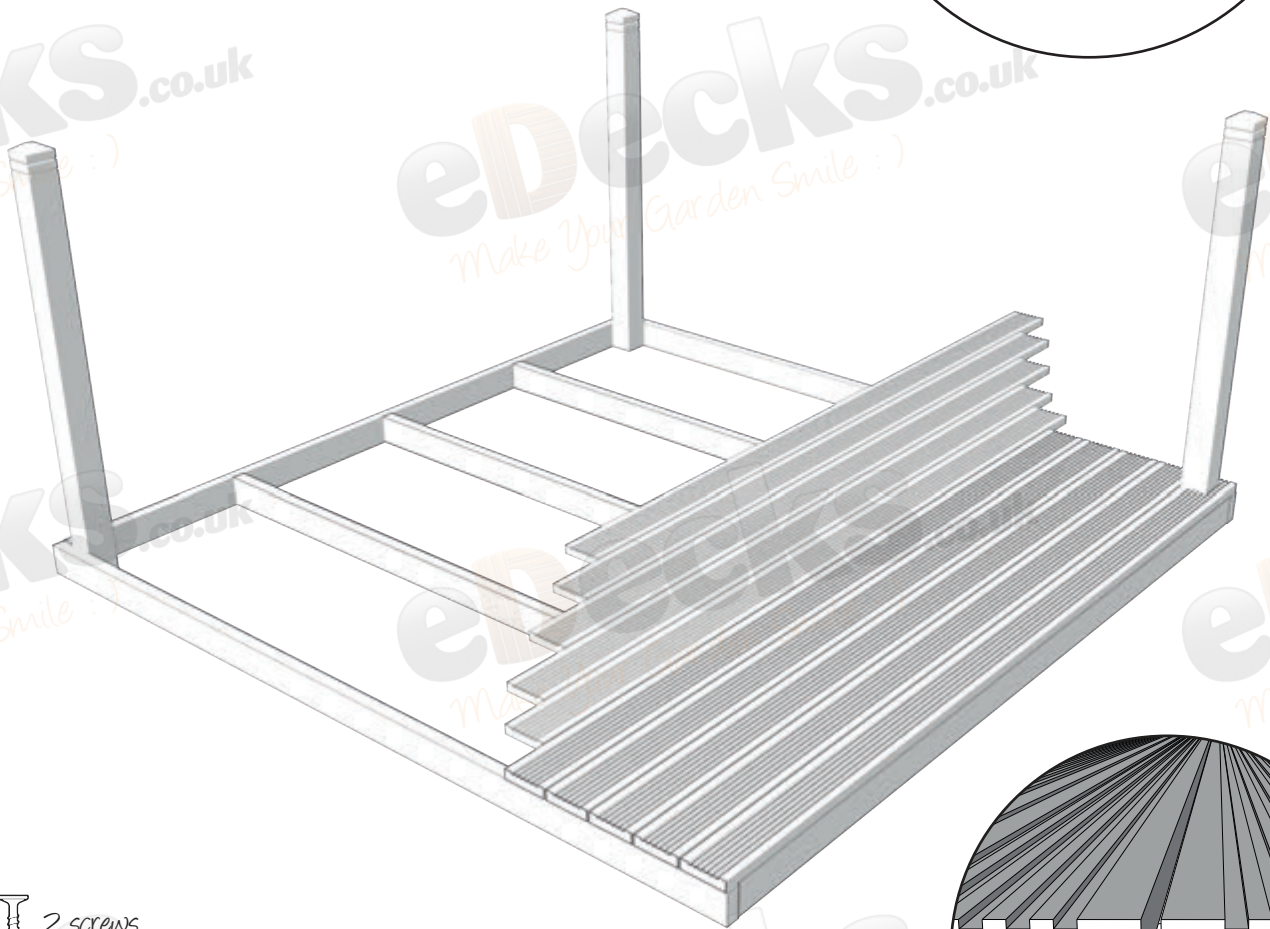
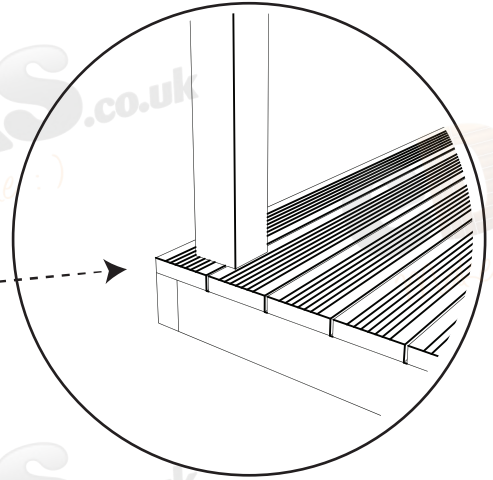

Don't forget to check your work with a level as you go!

Page 3 of 7

All images are for illustration only, Please see individual item listings for actual item specifications



Step 3 - Cont'd

INSTALL DECKING BOARDS

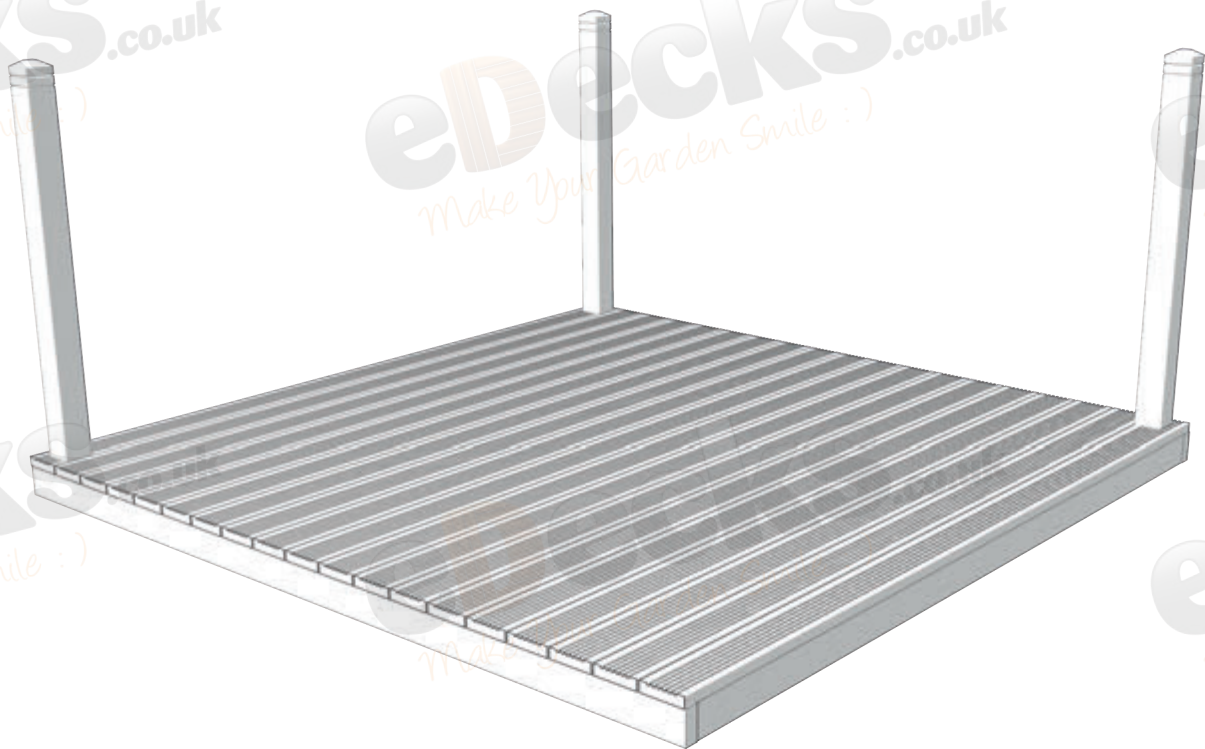

Don't forget to check your work with a level as you go!

Page 4 of 7

All images are for illustration only, Please see individual item listings for actual item specifications



Step 4

ROPE HANDRAIL SYSTEM

The rope will need cutting to the right length for your chosen kit size. The rope should measure an additional 0.5M on top of the length of your span, measure out and cut the rope on the ground before fixing to your newels. Measure accurately where to place the rope cups and screw these into the centre of your newel post using 3 screws in each cup.

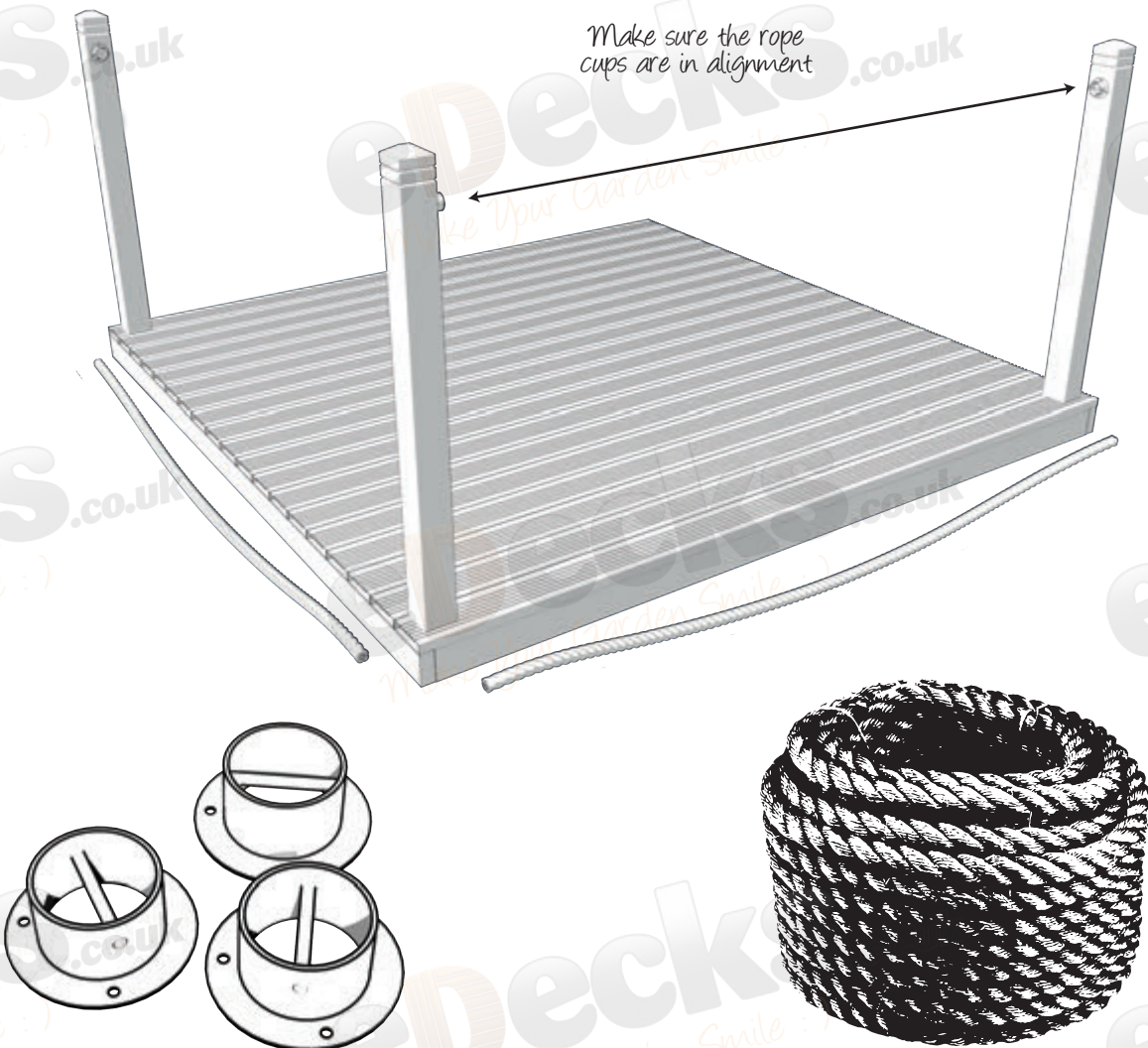

Don't forget to check your work with a level as you go!

Page 5 of 7

All images are for illustration only, Please see individual item listings for actual item specifications



Step 4 - Cont'd

ROPE HANDRAIL SYSTEM

Insert the rope ends into the cups and close the cups to secure the rope using the bolt on the side.

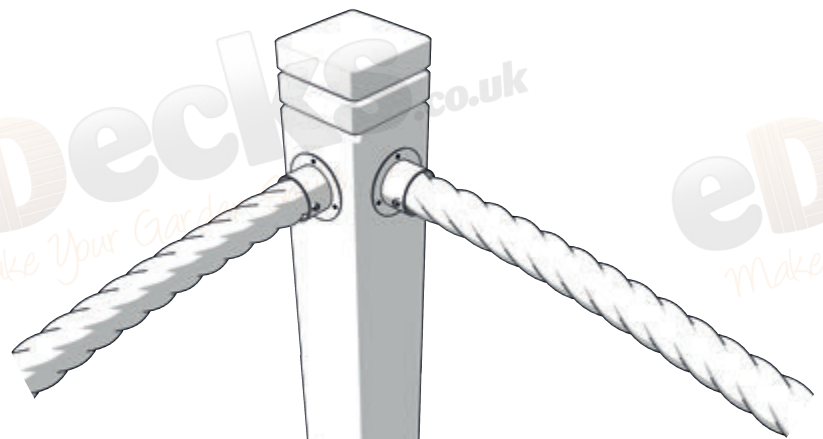
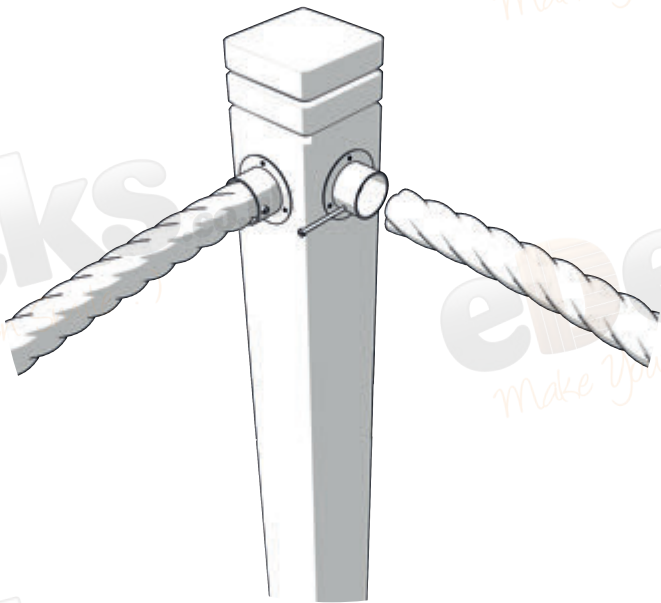

Don't forget to check your work with a level as you go!

Page 6 of 7

All images are for illustration only, Please see individual item listings for actual item specifications



Step 5

FINISH!

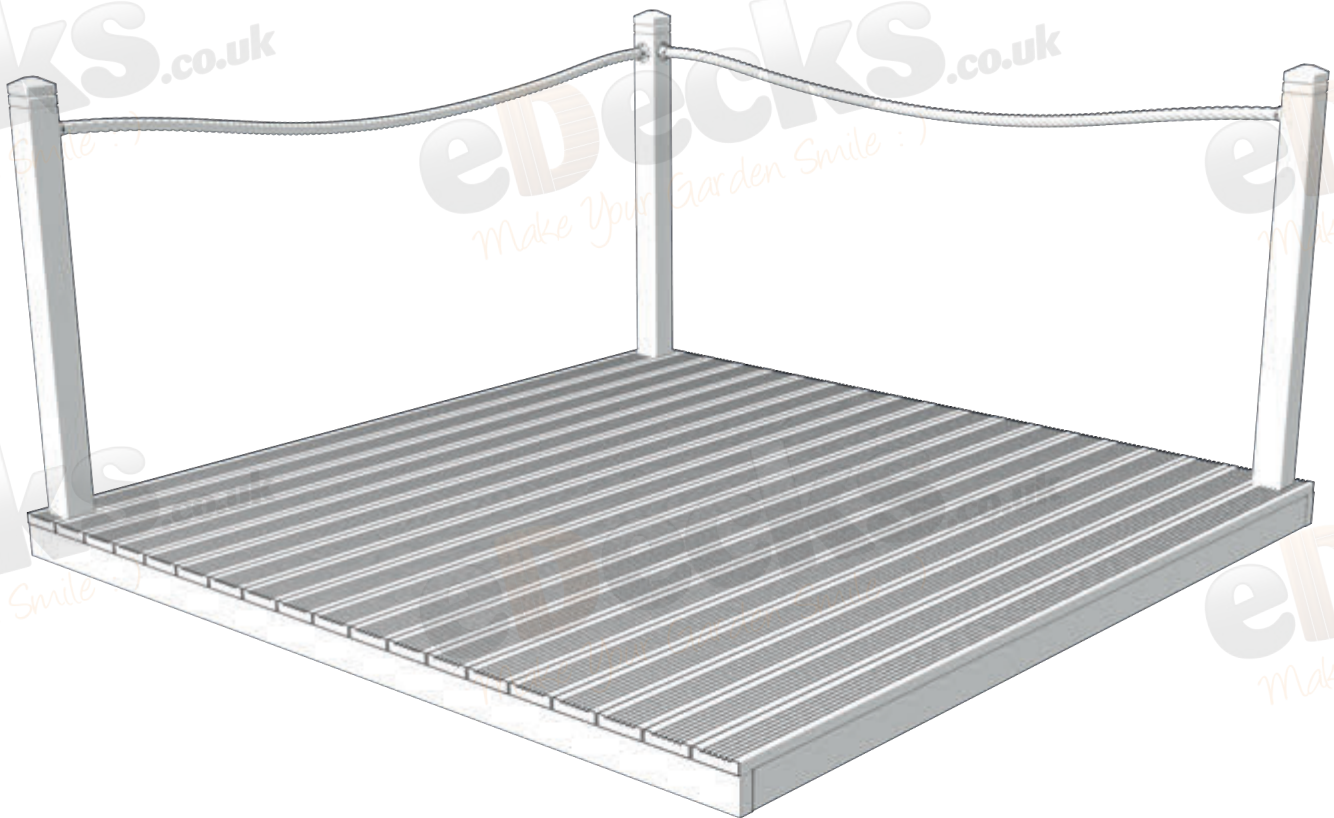

Once this is complete - Sit back and enjoy!

Page 7 of 7

All images are for illustration only, Please see individual item listings for actual item specifications