

# Lean To / Carport Pergola Fitting Instructions



## Step 1

### PREPARING THE SITE

Be sure to plan your site and measure accurately where your pergola posts need to be placed.

**Fig D** It is advisable to mark the support rafters where each the roof rafters will be fixed before beginning assembly whilst still on the ground.

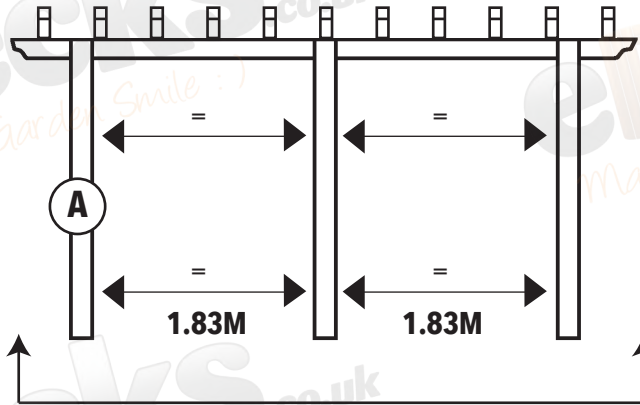

OVERALL WIDTH 3.6M, 4.2M OR 4.8M (DEPENDING ON KIT)

OVERALL LENGTH 4.8M

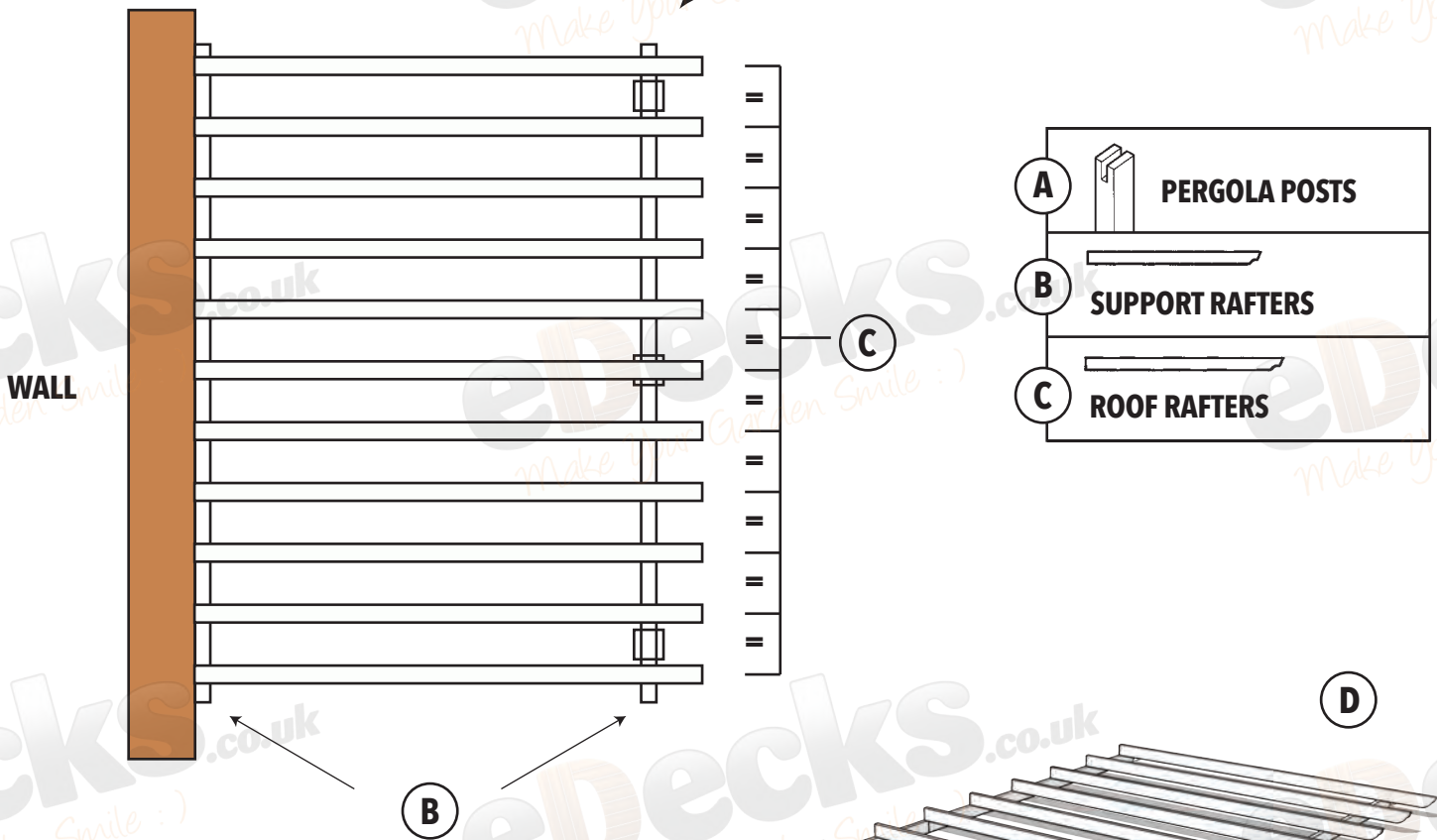

**PLEASE BE AWARE THAT THESE INSTRUCTIONS ARE RELAVENT FOR ALL KIT OPTIONS - 3.6M, 4.2M & 4.8M, 2.1M POSTS OR POSTS**

**Don't forget to check your work with a level as you go!**



## Step 2

### INSTALLING THE PERGOLA POSTS

Use the following diagrams to determine the distance your posts should be from your wall depending on your kit.

**3.6M KIT**

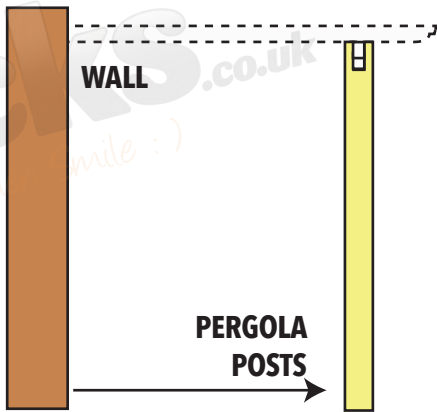

**POSTS MAX 3.4M  
AWAY FROM WALL**

**4.2M KIT**

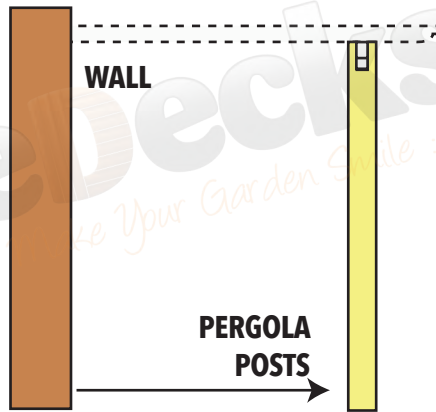

**POSTS MAX 4.0M  
AWAY FROM WALL**

**4.8M KIT**

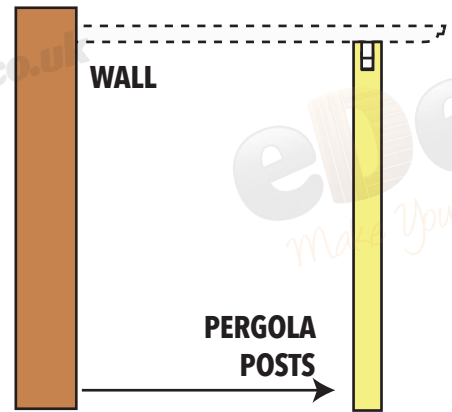

**POSTS MAX 4.6M  
AWAY FROM WALL**

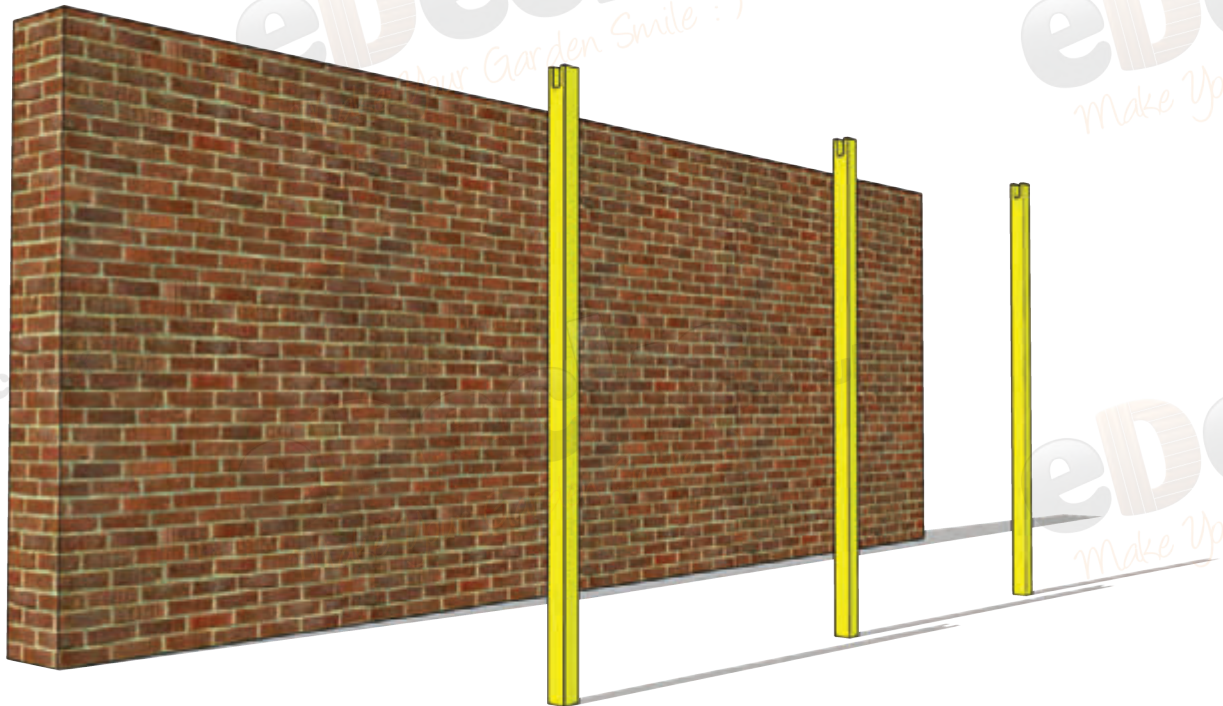

**Don't forget to check your work with a level as you go!**

## Step 2 Cont'd

### INSTALLING THE PERGOLA POSTS

Depending on your kit & post option you will need to follow one of the following options for each of the posts in your kit.

#### OPTION A

Excavate holes for the pergola posts. These need to be to a depth of 300mm (Kit option with 2.1M posts) or 600mm (Kit option with 2.7M Posts) then fill with concrete we recommend MetCrete to set quickly

#### Option B

Bolt Down Anchors - Attach the Bolt Down Anchor to your concrete area, drill an 8mm hole using an SDS drill bit, ensuring the hole depth is 10mm longer than the bolt length to allow for dust. Remove any loose dust and fix the bolt into place through the holes provided in the anchor. Slot your pergola post into the bolt down and tighten the 2 bolts at the side of the anchor to secure. Making sure its straight.

#### Option C

Steel Spikes - Using the Mett Driving tool and a sledge hammer or something equivalent drive the steel spike into the ground. Once post is in position tighten the 2 bolts on the side of the spike to secure post in place.

**IT IS CRITICAL THAT YOUR POSTS ARE AT EXACTLY THE SAME HEIGHT AND COMPLETELY STRAIGHT!**

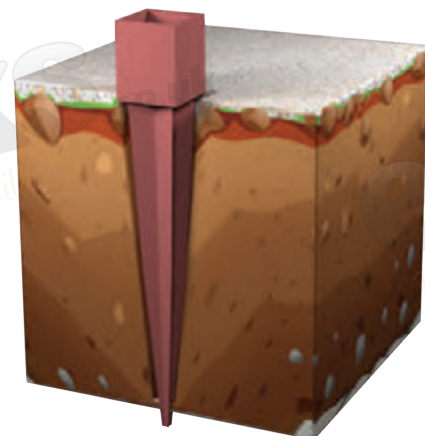
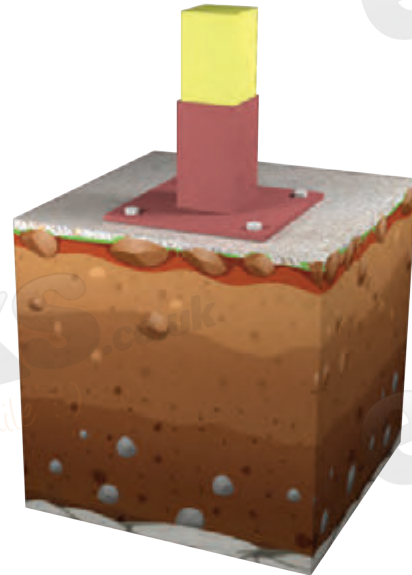
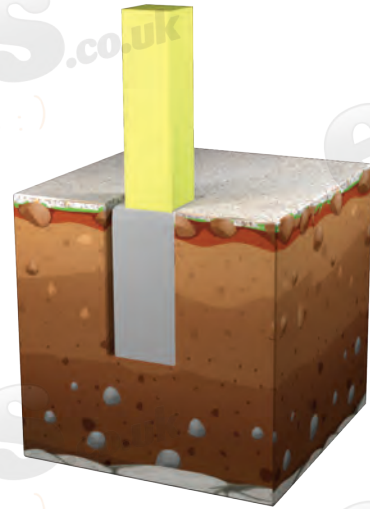

**Don't forget to check your work with a level as you go!**

## Step 3

### FITTING THE WALL SUPPORT RAFTERS

2 support rafters shown in yellow on the diagram below need fixing to your wall, these rafters should touch in the middle and must be level and centrally fixed using 3 screws in each. The bottom of this rafter should be in alignment with the notches in the pergola posts.

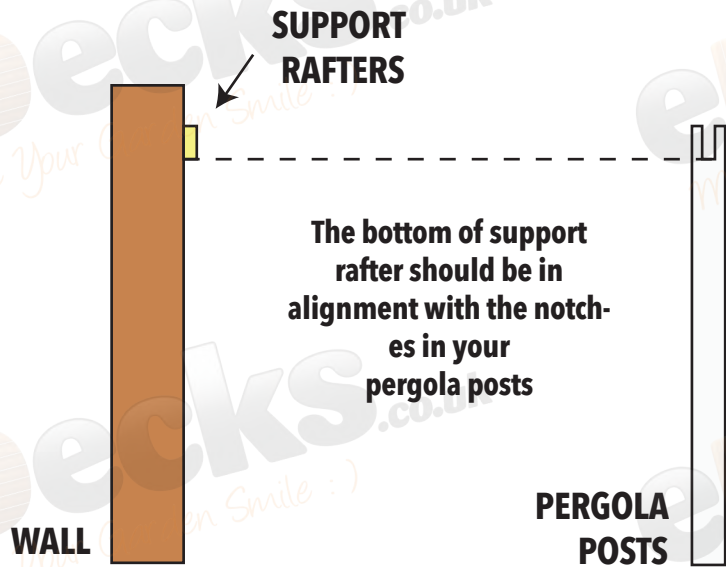

USE 3 SCREWS IN EACH RAFTER TO SECURE TO WALL

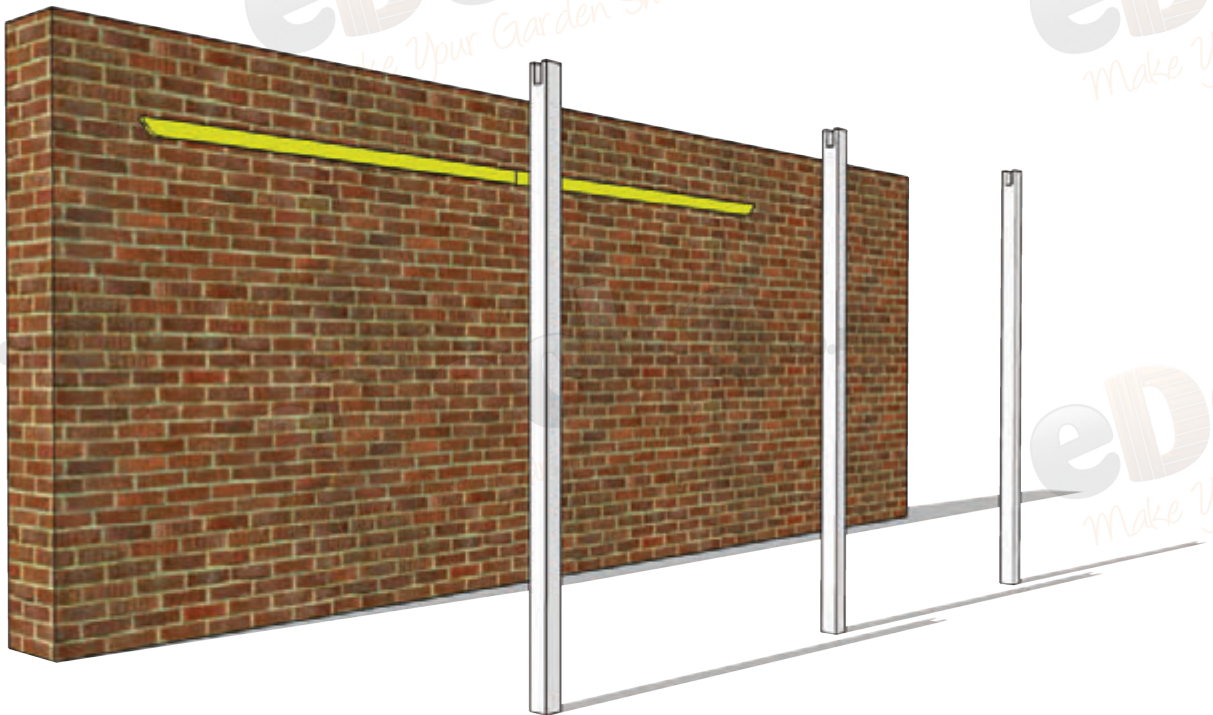

Don't forget to check your work with a level as you go!

## Step 4

### INSTALL SUPPORT RAFTERS

The 2 remaining support rafters now need fixing into position in the posts, these two rafters should join in the centre post **fig A**, use 4 screws per post **fig B** on each side of the post, to secure the rafters in place.

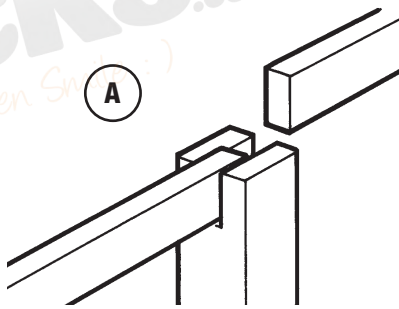

CENTRE POST

WALL

SUPPORT RAFTERS

PERGOLA POSTS

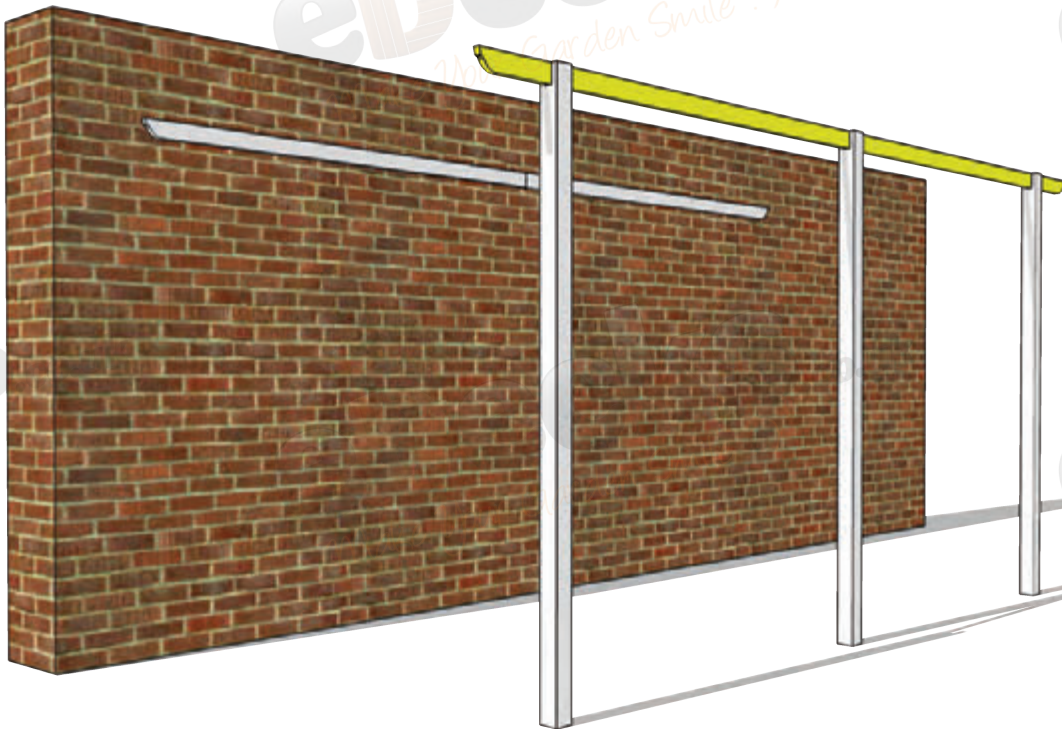
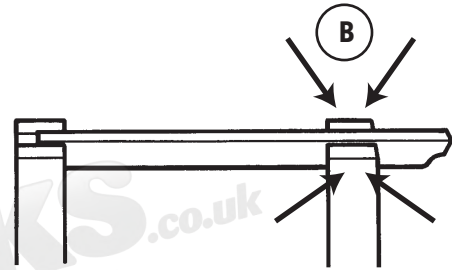

Don't forget to check your work with a level as you go!



## Step 5

### INSTALL THE ROOF RAFTERS

Now lift and secure each roof rafter into position as marked out in step 1. The roof rafters should be fastened to the support rafters with the 'U' clips in your kit **fig C**

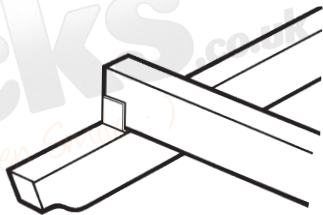

A

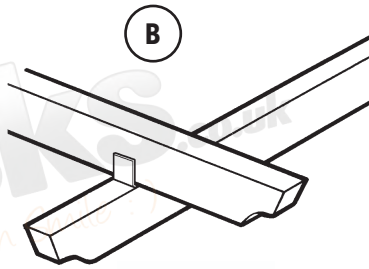

B

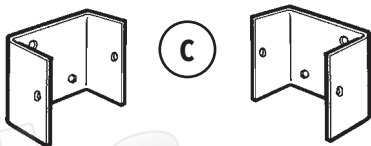

C

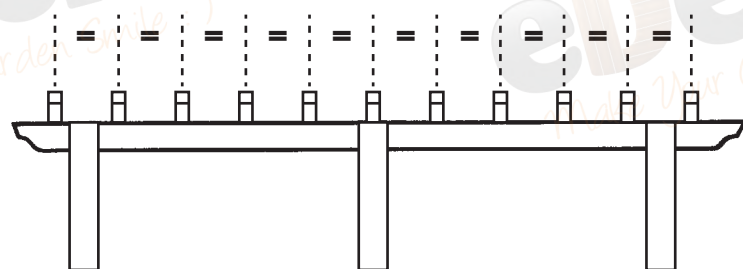

THE ROOF RAFTERS SHOULD BE EVENLY SPACED

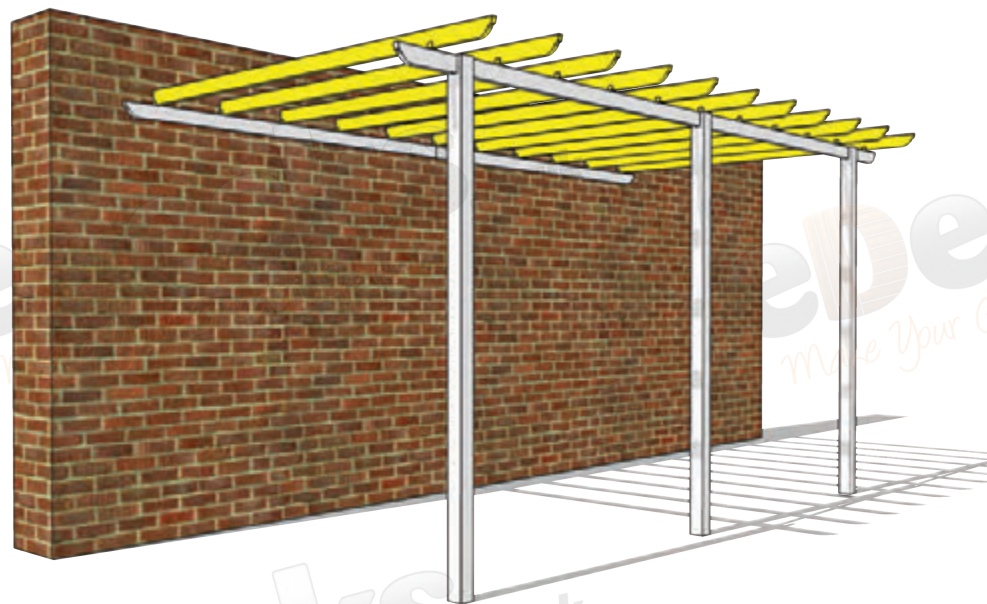
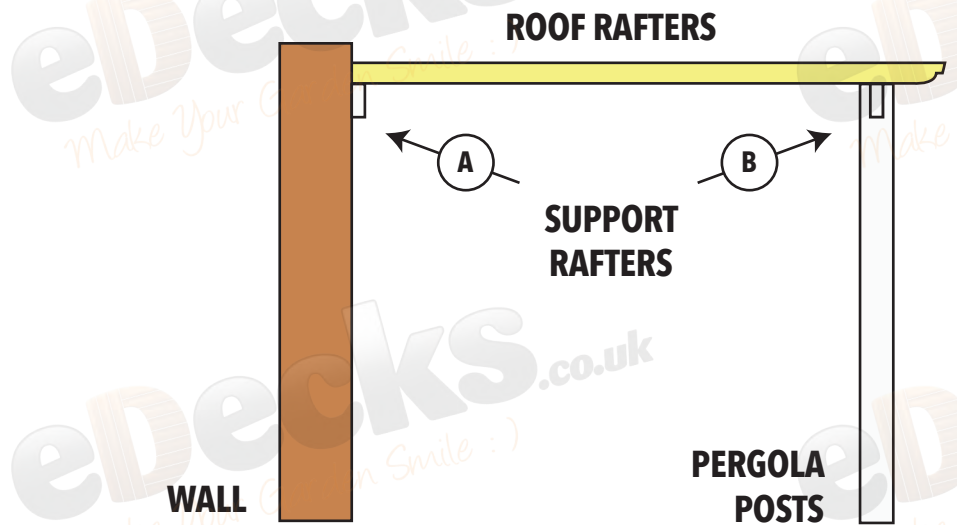

Don't forget to check your work with a level as you go!

Page 6 of 7

All images are for illustration only, Please see individual item listings for actual item specifications

## Step 6

**FINISH!**

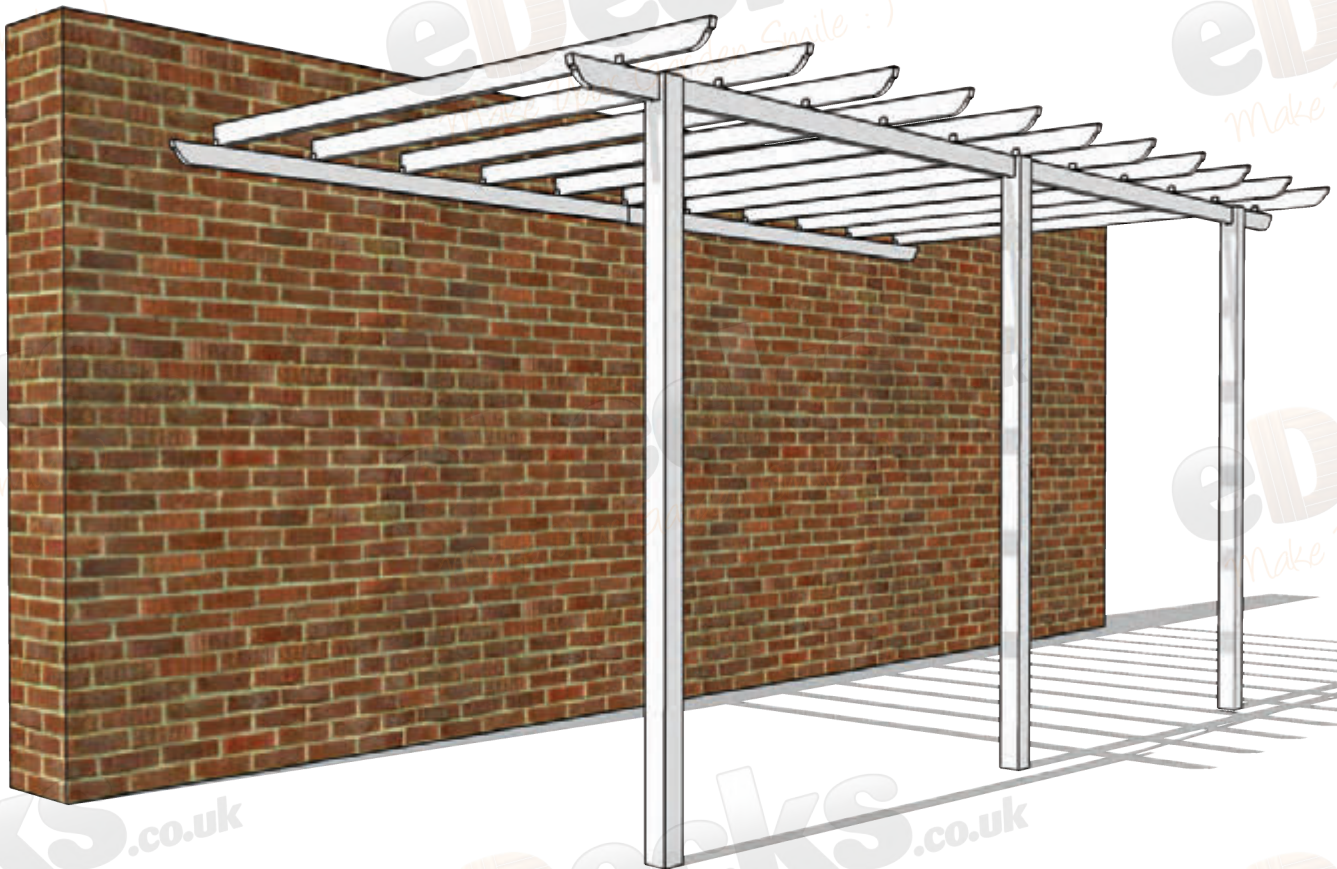

**Don't forget to check your work with a level as you go!**

**Page 7 of 7**

All images are for illustration only, Please see individual item listings for actual item specifications